

BRUSH STANDARD

ASSEMBLY GUIDE

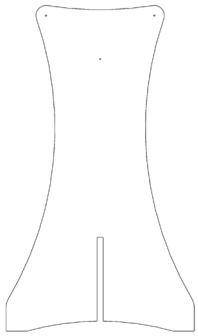

PART 01 X1

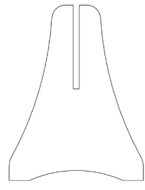

PART 02 X1

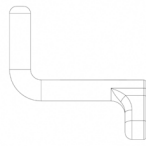

METAL HOOKS X6



SMALL SCREWS X6



BIG SCREWS X8

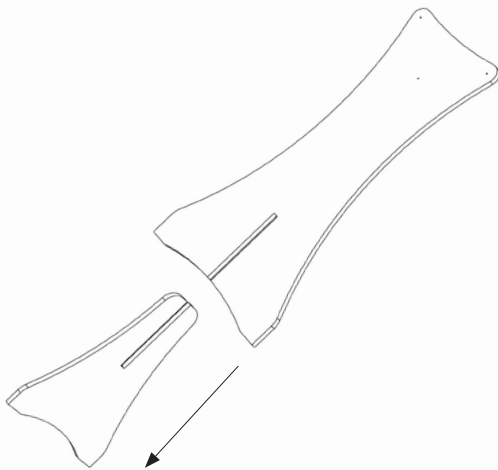

Step 1.

Take part 1 and slide it over (or in) part 2

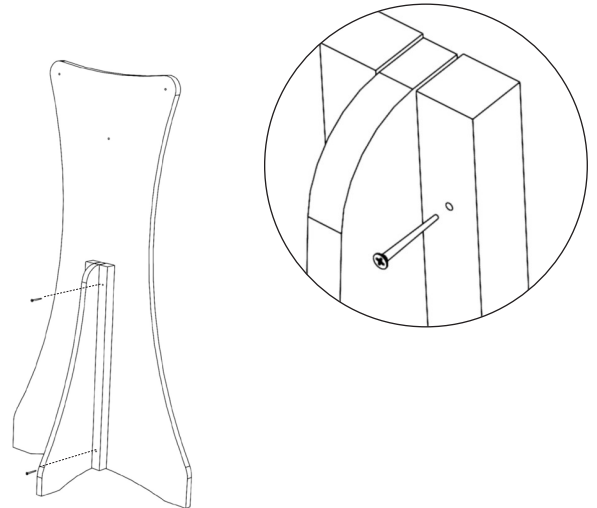

Step 2.

Connect part 1 and part 2 together by screwing 2 big screws for each corner.

Attention: be sure that all feet touch the floor before screwing.

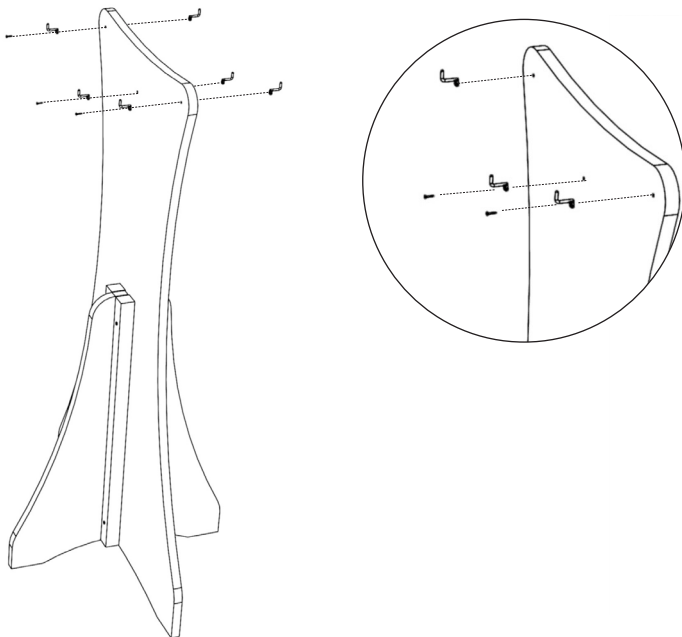

Step 3.

Connect each metal hook at both sides at the top of part 1 with one small screw in the pre-drilled hole.

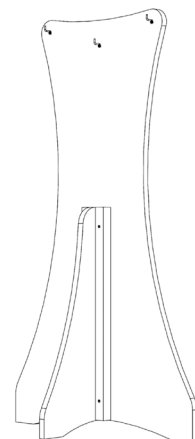

The brush holder is ready for use!

In case you need further information, please visit our website at

www.kgolf.nl

www.rolfeducation.com